

AI Motorized Pro Bullet Plus Network Camera

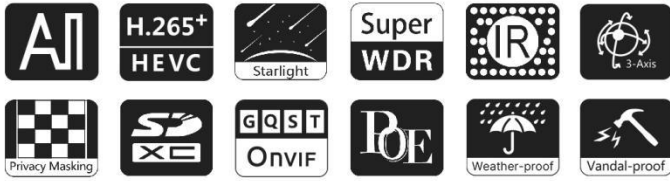

IP67 + IK10

Motorized Lens



DATASHEET

KEY FEATURES

- ▶ Smart IR II (Combining the High Beam and Low Beam to adjust IR intensity to fit different lighting conditions.)
- ▶ HLC (High Light Compensation. Improving image visibility under strong light sources.)
- ▶ P-Iris (Giving you a more clear scene with depth of view.)
- ▶ Defog (Defog technology. Restoring clear images in hazy and foggy weather.)
- ▶ 256G (Supporting ultra-large external microSD/SDHC/SDXC card storage up to 256G.)
- ▶ Smart Stream (Bandwidth, storage and bit rate are saved with Smart Stream On, eg, H.265+ saves 70%~80% bandwidth that of H.264.)

AI Video Analytics

- 8 intelligent VCA modes powered by AI engine, which can intelligently filter objects to focus on human and vehicle detection.
- People Counting technology provides high accuracy and real-time data based on AI algorithm with statistic reports.
- Face Detection function detects human faces in the monitoring scene and captures the snapshots, which greatly enhances the monitoring efficiency.



30fps@4K

Providing 4K HD resolution with frame rate of 30fps, the camera performs well in catching detailed image regardless of the moving speed.



3 in 1 Super WDR Pro & 0.002Lux Ultra Low-light

140dB Super WDR Pro combines 3 frames with multiple exposures to get the optimal images especially moving subjects in high contrast lighting situations. Meanwhile, the cameras can capture full-color images in extremely low-light conditions reaching 0.002Lux without extra light supplement.



Integrated Cable Management Bracket

In the base support, there are power interface, PoE port, Audio I/O and Alarm I/O interfaces. Thanks to the Integrated Cable Management, it takes no effort in installation. Besides, the creative clamshell design minimizes the installation troubles and enlarges the space to make cable connection a piece of cake.

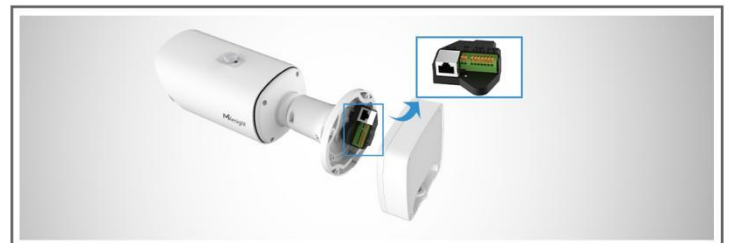

AI Motorized Pro Bullet Plus Network Camera



	Model	MS-C2866-TF(I)PC (2MP)	MS-C2966-R(T)F(I)PC (2MP)	MS-C5366-F(I)PC (5MP)
Camera	Image Sensor	1/2" Progressive Scan CMOS		1/2.8" Progressive Scan CMOS
	Min. Illumination	Color: 0.002Lux@F1.4 B/W: 0Lux with IR on	Color: 0.005Lux@F1.4 B/W: 0Lux with IR on	Color: 0.008Lux@F1.4 B/W: 0Lux with IR on
	WDR	140dB Super WDR Pro	140dB Super WDR (Super WDR Pro is optional for T Series)	120dB Super WDR
	Shutter Time	1/100000s~1s		
	IR Distance	Up to 65m	Up to 65m(3.0~10.5mm/2.7~13.5mm) Up to 100m(7~22mm)	
	Day/Night Mode	Day/Night/Auto/Customize/Schedule		
	S/N	>55dB		
Lens	Lens	Motorized 3.6~10mm@F1.4 P-Iris(Optional)	Motorized 2.7~13.5mm/3.0~10.5mm/7~22mm@F1.4 P-Iris(Optional)	
	Field of View	H100°~H45°/ D116°~D51°/ V57°~V25°	H113°~H33°/D130°~D38° /V60°~V18° (2.7~13.5mm) H104°~H34°/D120°~D39° /V57°~V19° (3.0~10.5mm) H45°~H17°/D53°~D20° /V25°~V9° (7~22mm)	H113°~H33°/D138°~D42° /V83°~V25° (2.7~13.5mm) H94°~H33°/ D116°~D42° / V71°~V25°(3.0~10.5mm) H42°~H16°/D53°~D20° /V32°~V12° (7~22mm)
	Mount	Φ14		
	Focus Control	Auto/Manual		
	Iris Control (Optional for I Series)	Auto/Manual		
Video	Max. Image Resolution	1920x1080		2592x1944
	Primary Stream	60Hz: 100fps@(1920x1080), 60fps@(1920x1080, 1280x960, 1280x720, 704x576) 50Hz: 100fps@(1920x1080), 50fps@(1920x1080, 1280x960, 1280x720, 704x576)	60Hz: 100fps@(1920x1080)(Optional for T Series) , 60fps@(1920x1080, 1280x960, 1280x720, 704x576) 50Hz: 100fps@(1920x1080)(Optional for T Series) , 50fps@(1920x1080, 1280x960, 1280x720, 704x576)	60Hz: 30fps@(2592x1944), 45fps@(2048x1536), 60fps@(1920x1080, 1280x960, 1280x720, 704x576) 50Hz: 25fps@(2592x1944), 45fps@(2048x1536), 50fps@(1920x1080, 1280x960, 1280x720, 704x576)
	Secondary Stream	60Hz: 60fps@(704x576, 640x480, 640x360, 352x288, 320x240, 320x192, 320x180) 50Hz: 50fps@(704x576, 640x480, 640x360, 352x288, 320x240, 320x192, 320x180)	60Hz: 30fps@(704x576, 640x480, 640x360, 352x288, 320x240, 320x192, 320x180) 50Hz: 25fps@(704x576, 640x480, 640x360, 352x288, 320x240, 320x192, 320x180)	
	Tertiary Stream	60Hz: 30fps@(1920x1080, 1280x720, 704x576, 640x480, 640x360, 320x240, 320x192, 320x180) 50Hz: 25fps@(1920x1080, 1280x720, 704x576, 640x480, 640x360, 320x240, 320x192, 320x180)		
	Video Compression	H.265+/H.265(HEVC)/H.264+/H.264/MJPEG		
	Video Bit Rate	16Kbps~16Mbps(CBR/VBR Adjustable)		
	Privacy Masking	Up to 28 areas(24 mask areas and 4 mosaic areas)		
	ROI	Up to 8 areas		
Image Setting	Brightness/Contrast/Saturation/Sharpness			

AI Motorized Pro Bullet Plus Network Camera



Interface	Ethernet	1*RJ45 10M/100M Ethernet Port		
	Audio I/O	1/1		
	Alarm I/O	1/1		
Network	Network Storage	NAS(Support NFS, SMB/CIFS), ANR		
	Protocol	IPv4/IPv6, ARP, TCP, UDP, RTCP, RTP, RTSP, RTMP, HTTP, HTTPS, DNS, DDNS, DHCP, FTP, NTP, SMTP, SNMP, UPnP, Bonjour, SIP, PPPoE, VLAN, 802.1x, QoS, IGMP, ICMP, SSL		
Audio	Audio Compression	G.711/AAC/G.722/G.726		
	Audio Sampling Rate	8/16/32/44.1/48KHz		
	Audio Bit Rate	16~256kbps		
	Two-way Audio	Support		
Intelligent Analytics	Video Analysis	Region Entrance, Region Exiting, Advanced Motion Detection, Tamper Detection, Line Crossing, Loitering, Object Left, Object Removed		
	Face Detection	Detect and capture faces, get real-time snapshots		
	People Counting&Report	Count the number of people entering or exiting, up to 4 detection areas for regional people counting		
System	Storage	microSD/SDHC/SDXC Card Local Storage, up to 256G		
	Advanced Function	Heat Map, BLC, HLC, 2D DNR, 3D DNR, Defog, AWB, EIS, IP Address Filtering, AGC, Anti-flicker, Corridor Mode, Deblur, Watermark		
	SIP/VoIP Support	Yes, Voice & Video-over-IP		
	Event Trigger	Motion Detection, Network Disconnection, External Input, Audio Alarm, etc.		
	Event Action	FTP Upload, SMTP Upload, SD Card Record, External Output, SIP Phone, HTTP Notification, etc.		
	System Compatibility	ONVIF Profile G & Q & S & T, API		
General	Working Temperature	-40°C~60°C		
	Working Humidity	0~90%(Non-condensing)		
	Power Supply	PoE (802.3af) / DC 12V±10%		
	Power Consumption	7W MAX 15W MAX(With IR on)	8W MAX 16W MAX(With IR on)	7W MAX 16W MAX(With IR on)
	Housing	Vandal-proof IK10-rated Metal Housing / Up to IP67-rated for Weather-resistant Performance		
	Surge Protection	4KV		
	Weight	1630g		
	Dimensions	301mmX108mmX126mm		
	Warranty	3/5 Years		

AI Motorized Pro Bullet Plus Network Camera



	Model	MS-C8166-F(I)PC (4K)	MS-C8266-F(I)PC (4K)
Camera	Image Sensor	1/2.8" Progressive Scan CMOS	1/1.8" Progressive Scan CMOS
	Min. Illumination	Color: 0.012Lux@F1.4 B/W: 0Lux with IR on	Color: 0.009Lux@F1.4 B/W: 0Lux with IR on
	WDR	120dB Super WDR	
	Shutter Time	1/100000s~1s	
	IR Distance	Up to 65m	
	Day/Night Mode	Day/Night/Auto/Customize/Schedule	
	S/N	>55dB	
	Lens	Lens	Motorized 2.7~13.5mm@F1.4 P-Iris(Optional)
Field of View		H110°~H33°/D118°~D38°/V60°~V18°	H116°~H48°/D134°~D55°/V65°~V27°
Mount		Φ14	
Focus Control		Auto/Manual	
Iris Control (Optional for I Series)		Auto/Manual	
Video	Max. Image Resolution	3840x2160	
	Primary Stream	60Hz: 30fps@(3840x2160, 3072x2048, 2592x1944, 2592x1520, 2048x1536, 1920x1080, 1280x960, 1280x720, 704x576) 50Hz: 25fps@(3840x2160, 3072x2048, 2592x1944, 2592x1520, 2048x1536, 1920x1080, 1280x960, 1280x720, 704x576)	
	Secondary Stream	60Hz: 30fps@(704x576, 640x480, 640x360, 352x288, 320x240, 320x192, 320x180) 50Hz: 25fps@(704x576, 640x480, 640x360, 352x288, 320x240, 320x192, 320x180)	
	Tertiary Stream	60Hz: 30fps@(1920x1080, 1280x720, 704x576, 640x480, 640x360, 320x240, 320x192, 320x180) 50Hz: 25fps@(1920x1080, 1280x720, 704x576, 640x480, 640x360, 320x240, 320x192, 320x180)	
	Video Compression	H.265+/H.265(HEVC)/H.264+/H.264/MJPEG	
	Video Bit Rate	16Kbps~16Mbps(CBR/VBR Adjustable)	
	Privacy Masking	Up to 28 areas(24 mask areas and 4 mosaic areas)	
	ROI	Up to 8 areas	
	Image Setting	Brightness/Contrast/Saturation/Sharpness	
Interface	Ethernet	1*RJ45 10M/100M Ethernet Port	
	Audio I/O	1/1	
	Alarm I/O	1/1	
Network	Network Storage	NAS(Support NFS, SMB/CIFS), ANR	
	Protocol	IPv4/IPv6, ARP, TCP, UDP, RTCP, RTP, RTSP, RTMP, HTTP, HTTPS, DNS, DDNS, DHCP, FTP, NTP, SMTP, SNMP, UPnP, Bonjour, SIP, PPPoE, VLAN, 802.1x, QoS, IGMP, ICMP, SSL	

AI Motorized Pro Bullet Plus Network Camera



Audio	Audio Compression	G.711/AAC/G.722/G.726
	Audio Sampling Rate	8/16/32/44.1/48KHz
	Audio Bit Rate	16~256kbps
	Two-way Audio	Support
Intelligent Analytics	Video Analysis	Region Entrance, Region Exiting, Advanced Motion Detection, Tamper Detection, Line Crossing, Loitering, Object Left, Object Removed
	Face Detection	Detect and capture faces, get real-time snapshots
	People Counting&Report	Count the number of people entering or exiting, up to 4 detection areas for regional people counting
System	Storage	microSD/SDHC/SDXC Card Local Storage, up to 256G
	Advanced Function	Heat Map, BLC, HLC, 2D DNR, 3D DNR, Defog, AWB, EIS, IP Address Filtering, AGC, Anti-flicker, Corridor Mode, Deblur, Watermark
	SIP/VoIP Support	Yes, Voice & Video-over-IP
	Event Trigger	Motion Detection, Network Disconnection, External Input, Audio Alarm, etc.
	Event Action	FTP Upload, SMTP Upload, SD Card Record, External Output, SIP Phone, HTTP Notification, etc.
	System Compatibility	ONVIF Profile G & Q & S & T, API
General	Working Temperature	-40°C~60°C
	Working Humidity	0~90%(Non-condensing)
	Power Supply	PoE (802.3af) / DC 12V±10%
	Power Consumption	8W MAX 17W MAX (With IR on)
	Housing	Vandal-proof IK10-rated Metal Housing / Up to IP67-rated for Weather-resistant Performance
	Surge Protection	4KV
	Weight	1630g
	Dimensions	301mmX108mmX126mm
	Warranty	3/5 Years

AI Motorized Pro Bullet Plus Network Camera



Structure Diagrams

microSD/SDHC/SDXC Card Slot

Reset

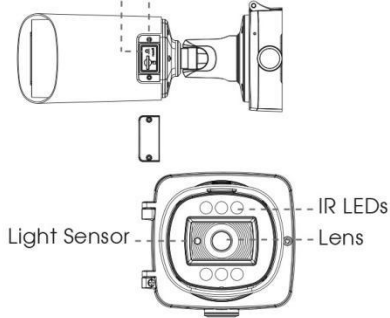

Ethernet Port (PoE)

Alarm/Audio

DC 12V

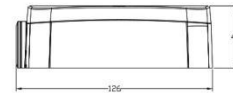
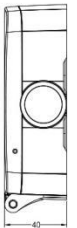
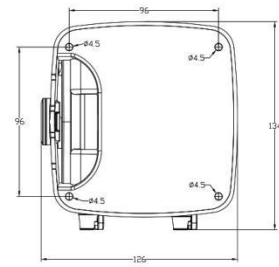
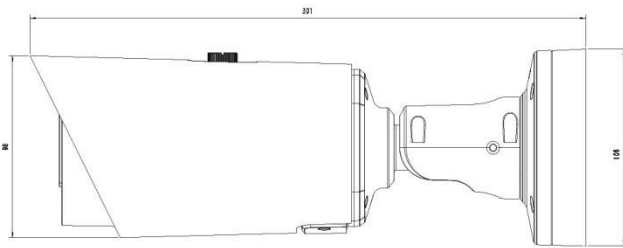
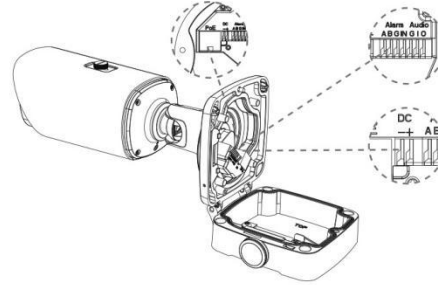

Units: mm

Accessories Support

A62 Junction Box(Default)

Weight: 510g
Dimensions: 134*126*40mm



A01 Pole Mount

Weight: 720g
Dimensions: 170*51.5*152.6mm



A03 External Corner Bracket

Weight: 900g
Dimensions: 170*152.5*76.3mm



Milesight | www.milesight.com

Contact Us: sales@milesight.com support@milesight.com

Add: 220 NE 51st Street, Oakland Park, Florida 33334, USA
Tel: +1-800-561-0485

Add: 925, Anyang SK V1 Center, LS-ro 116beon-gil, Dongan-gu, Anvang-si, Korea
Tel: +82-31-990-7732

Add: Building C09, Software Park Phase III, Xiamen 361024, Fujian, China
Tel: +86-592-5922772

