

H.265+ Mini Bullet Network Camera



DATASHEET

KEY FEATURES

- ▶ **Smart Stream** (Bandwidth, storage and bit rate are saved with Smart Stream On, eg, H.265+ saves 70%~80% bandwidth that of H.264.)
- ▶ **Powerful IR LEDs** (Equipped with 3rd generation dot matrix IR LEDs, guaranteeing excellent image quality, long lifespan and energy efficiency.)
- ▶ **Advanced Functions** (Boasting to support various advanced functions such as HLC, Defog, ROI.)
- ▶ **256G** (Supporting ultra-large external microSD/SDHC/SDXC card storage up to 256G.)
- ▶ **Adjustable 3-Axis Bracket** (Providing a robust mounting platform for angle adjustments on a 3-axis plane.)

30fps@4K

Providing 4K HD resolution with frame rate of 30fps, the camera performs well in catching detailed image regardless of the moving speed.

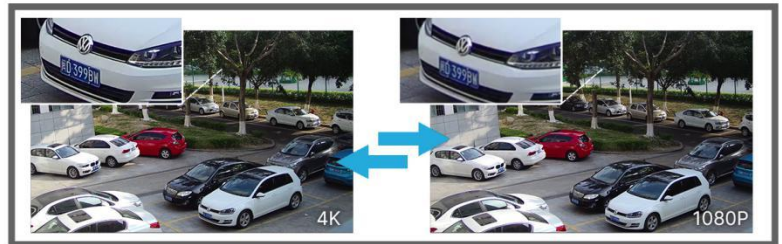

0.002Lux Ultra Low-light

The starlight camera is able to deliver high detailed color images even in low light environment reaching 0.002Lux(Color) or 0Lux(B/W), and near infrared light environments without any supplementary lighting.

140dB Super WDR

Milesight's sensor-based WDR technology allows the camera to record greater scene details with true color reproduction even under the extreme back light and high contrast conditions. The ratio that the brightest light signal values divided by the darkest light signal values



IP67&IK10

Supporting IP67-rated weather proofing and IK10-rated vandal proof which are the leading level of the industry, the camera is well protected against adverse impact to ensure the performance.

H.265+ Mini Bullet Network Camera



	Model	MS-C2963-(R)PB (2MP)	MS-C5363-(H)PB (5MP)	MS-C8163-(H)PB (4K)
Camera	Image Sensor	1/2.8" Progressive Scan CMOS		
	Min. Illumination	Color: 0.002Lux@F1.2 Color: 0.005Lux@F1.6/F2.0 B/W: 0Lux with IR on	Color: 0.005Lux@F1.2 Color: 0.008Lux@F1.6/F2.0 B/W: 0Lux with IR on	Color: 0.01Lux@F1.2 Color: 0.012Lux@F1.6/F2.0 B/W: 0Lux with IR on
	WDR	140dB Super WDR	120dB Super WDR	
	Lens	4mm/2.8mm/6mm @F1.6		
	Mount	M12		
	Field of View	H91°/D106°/V50°(4mm) H111°/D128°/V61°(2.8mm) H55°/D63°/V32°(6mm)	H86°/D108°/V63°(4mm) H105°/D131°/V78°(2.8mm) H52°/D63°/V40°(6mm)	H91°/D106°/V50°(4mm) H110°/D126°/V60°(2.8mm) H55°/D63°/V32°(6mm)
	Shutter Time	1/100000s~1s		
	IR Distance	Up to 50m		
	Day/Night Mode	Day/Night/Auto/Customize/Schedule		
	S/N	>55dB		
Video	Max. Image Resolution	1920x1080	2592x1944	3840x2160
	Primary Stream	60fps@(1920x1080)(Optional for R Series), 30fps@(1920x1080, 1280x960, 1280x720, 704x576)	30fps@(2592x1944), 45fps@(2048x1536), 60fps@(1920x1080)(Optional for H Series), 20fps@(2592x1944), 30fps@(2048x1536, 1920x1080, 1280x960, 1280x720, 704x576)	30fps@(3840x2160)(Optional for H Series), 15fps@(3840x2160), 30fps@(3072x2048, 2592x1944, 2592x1520, 2048x1536, 1920x1080, 1280x960, 1280x720, 704x576)
	Secondary Stream	30fps(704x576, 640x480, 640x360, 352x288, 320x240, 320x192, 320x180)		
	Tertiary Stream	30fps@(1920x1080, 1280x720, 704x576, 640x480, 640x360, 320x240, 320x192, 320x180)		
	Video Compression	H.265+/H.265(HEVC)/H.264*/H.264/MJPEG		
	Video Bit Rate	16Kbps~16Mbps(CBR/VBR Adjustable)		
	Privacy Masking	Up to 8 areas		
	ROI	Up to 8 areas		
Image Setting	Brightness/Contrast/Saturation/Sharpness			
Interface	Ethernet	1*RJ45 10M/100M Ethernet Port		
	Audio I/O	1/1 (Multi-interface Version)		
	Alarm I/O	1/1 (Multi-interface Version)		
Network	Network Storage	NAS(Support NFS, SMB/CIFS), ANR		
	Protocol	IPv4/IPv6, ARP, TCP, UDP, RTCP, RTP, RTSP, RTMP, HTTP, HTTPS, DNS, DDNS, DHCP, FTP, NTP, SMTP, SNMP, UPnP, Bonjour, SIP, PPPoE, VLAN, 802.1x, QoS, IGMP, ICMP, SSL		
Audio	Audio Compression	G.711/AAC/G.722/G.726		
	Audio Sampling Rate	8/16/32/44.1/48KHz (44.1KHz is available for all except R Series.)	8/16/32/48KHz (32KHz and 48KHz are available for H Series.)	8/16/32/48KHz
	Audio Bit Rate	16~256kbps	16~96kbps, 16~256kbps(Optional for H Series)	16~256kbps
	Two-way Audio	Support		

H.265+ Mini Bullet Network Camera



System	Storage	Support microSD/SDHC/SDXC Card Local Storage, up to 256G		
	Advanced Function	BLC, HLC, 2D DNR, 3D DNR, Defog, AWB, EIS, IP Address Filtering, AGC, Anti-flicker, Corridor Mode, Deblur, Watermark		
	SIP/VoIP Support	Yes, Voice & Video-over-IP		
	Event Trigger	Motion Detection, Network Disconnection, etc. ; Motion Detection, Network Disconnection, External Input, Audio Alarm, etc. (Multi-interface Version)		
	Event Action	FTP Upload, SMTP Upload, SD Card Record, SIP Phone, HTTP Notification, etc. ; FTP Upload, SMTP Upload, SD Card Record, External Output, SIP Phone, HTTP Notification, etc. (Multi-interface Version)		
	Video Analysis	Region Entrance, Region Exiting, Advanced Motion Detection, Tamper Detection, Line Crossing, Loitering, Human Detection, People Counting, Object Left, Object Removed		
	System Compatibility	ONVIF Profile G & Q & S & T, API		
General	Working Temperature	-40°C~60°C		
	Working Humidity	0~90%(Non-condensing)		
	Power Supply	PoE (802.3af); PoE (802.3af) / DC 12V ± 10% (Multi-interface Version)		
	Power Consumption	4W MAX 5.5W MAX (With IR on)	4.5W MAX 6W MAX (With IR on)	6W MAX 7W MAX (With IR on)
	Weather Proof	Up to IP67-rated for Weather-resistant Performance		
	Housing	Vandal-proof IK10-rated Metal Housing		
	Weight	750g		
	Dimensions	Φ76mmX214.5mm		
	Warranty	3/5 Years		

H.265+ Mini Bullet Network Camera



Structure Diagrams

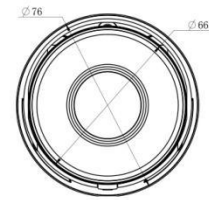
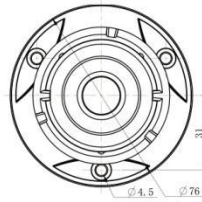
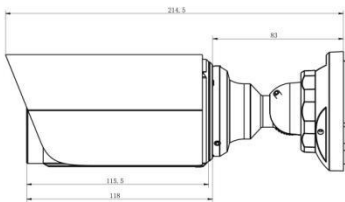
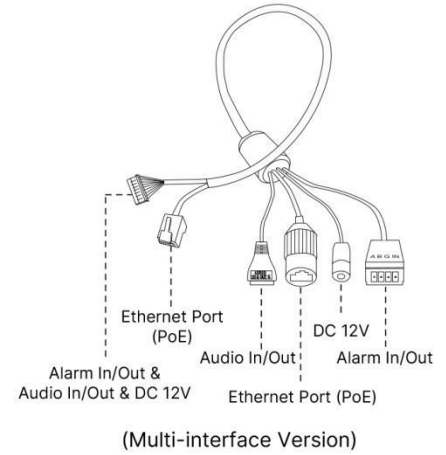
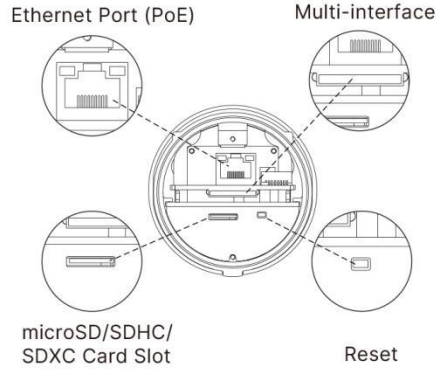
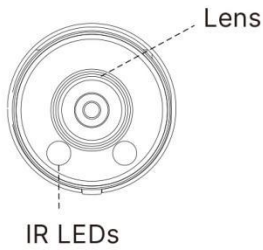

Units: mm

Accessories Support

A01 Pole Mount

Weight: 720g
Dimensions: 170*51.5*152.6mm



A03 External Corner Bracket

Weight: 900g
Dimensions: 170*152.5*76.3mm



A63 Junction Box

Weight: 620g
Dimensions: 134*126*40mm



Milesight Technology Co., Ltd. | www.milesight.com

Contact Us: sales@milesight.com support@milesight.com

Add: 220 NE 51st Street, Oakland Park, Florida 33334, USA
Tel: +1-800-561-0485

Add: 925, Anyang SK V1 Center, LS-ro 116beon-gil, Dongan-gu, Anyang-si, Korea
Tel: +82-31-990-7732

Add: No.23 Wanghai Road, 2nd Software Park, Xiamen, China
Tel: +86-592-5922772

